

 STORA-DRAIN	Nazwa: TOP B=100 H=65 L=1000
Rodzaj materiału: polimerobeton	Klasa wytrzymałości: A15 - C250
Ochrona krawędzi: -	Numer artykułu: ST10061000

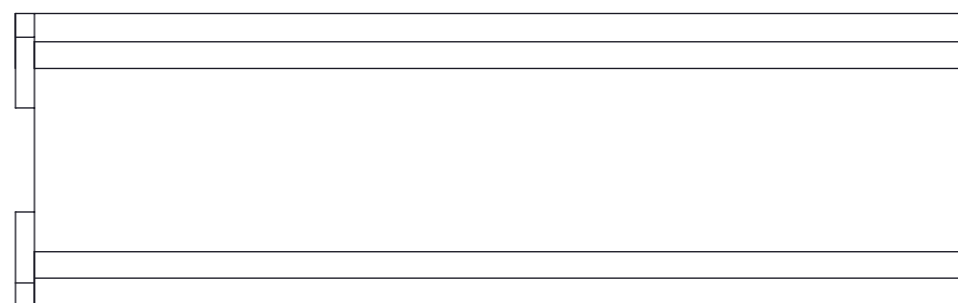

 STORA-DRAIN	Nazwa: TOP B=100 H=100 L=1000
Rodzaj materiału: polimerobeton	Klasa wytrzymałości: A15 - C250
Ochrona krawędzi: -	Numer artykułu: ST10101000

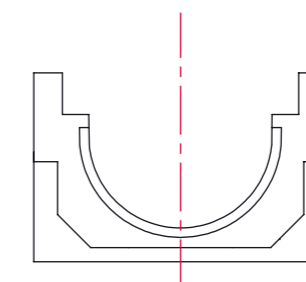
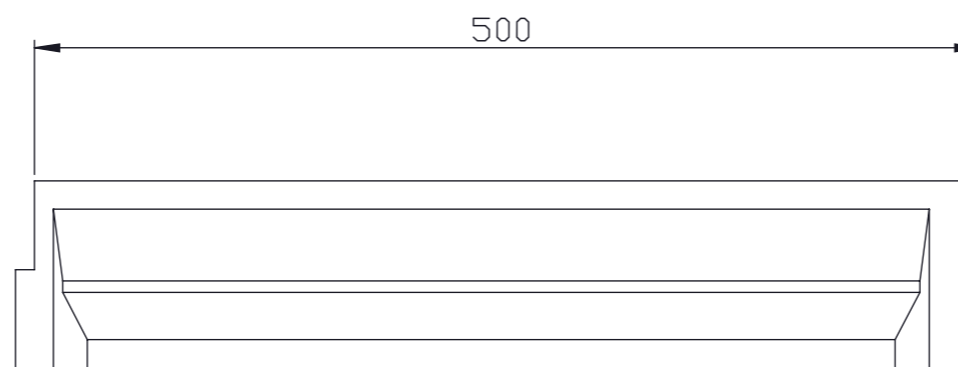
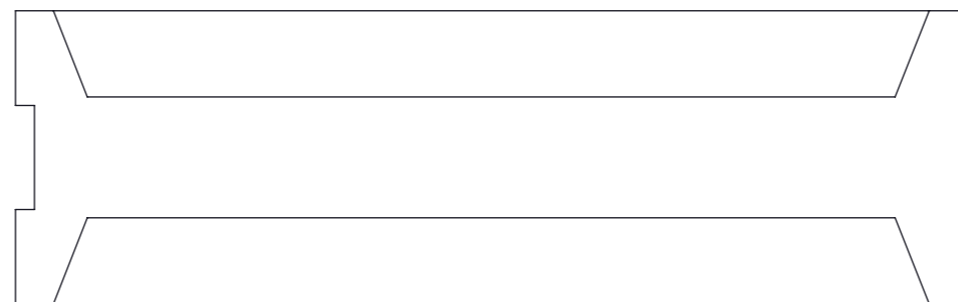
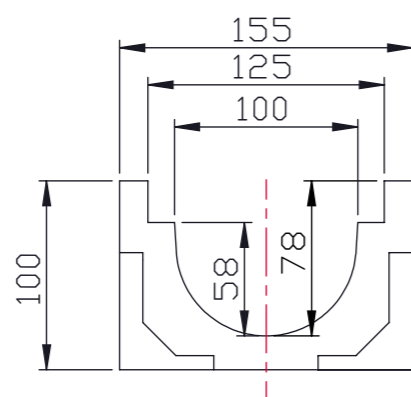

 STORA-DRAIN	Nazwa: TOP B=100 H=100 L=500
Rodzaj materiału: polimerobeton	Klasa wytrzymałości: A15 - C250
Ochrona krawędzi: -	Numer artykułu: ST10105000

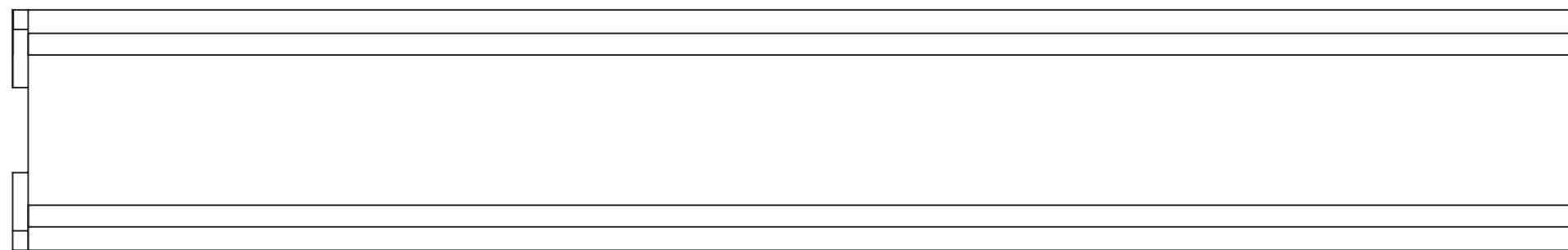
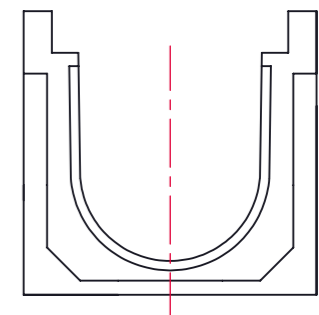
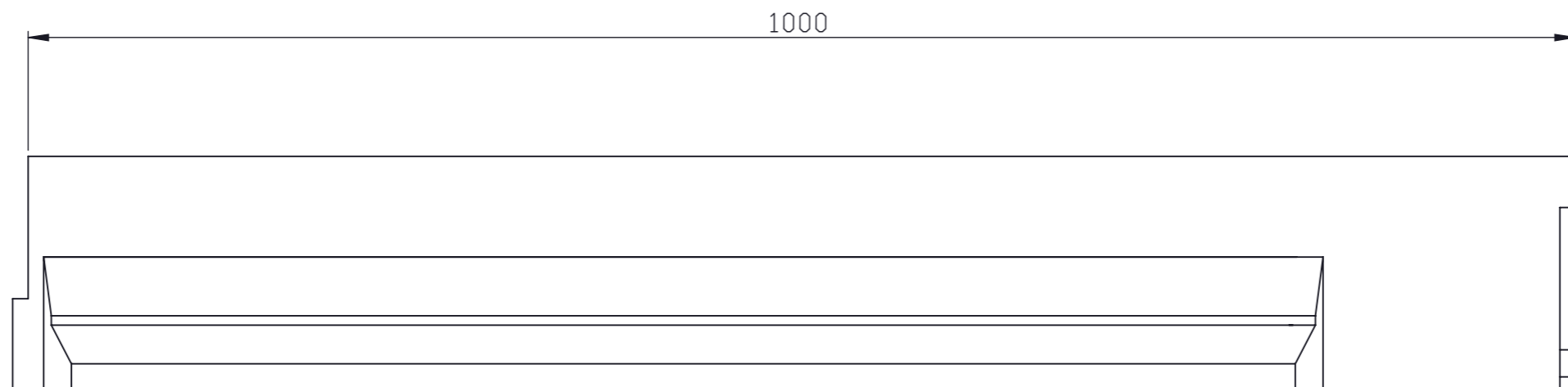
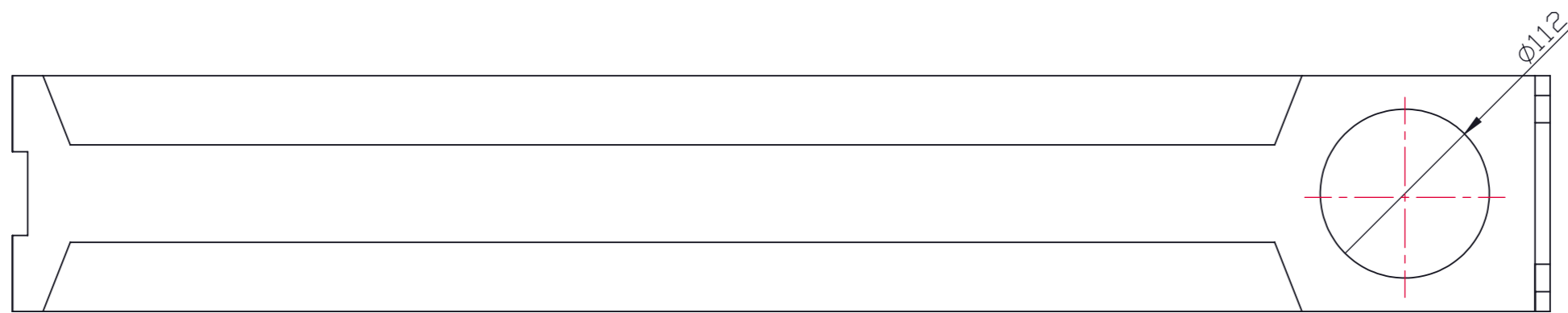
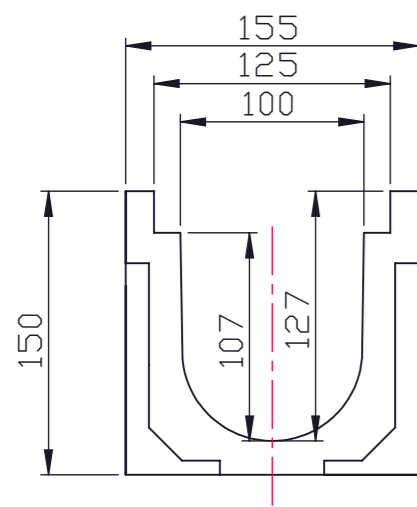

 STORA-DRAIN	Nazwa: TOP B=100 H=150 L=1000
Rodzaj materiału: polimerobeton	Klasa wytrzymałości: A15 - C250
Ochrona krawędzi: -	Numer artykułu: ST10151000

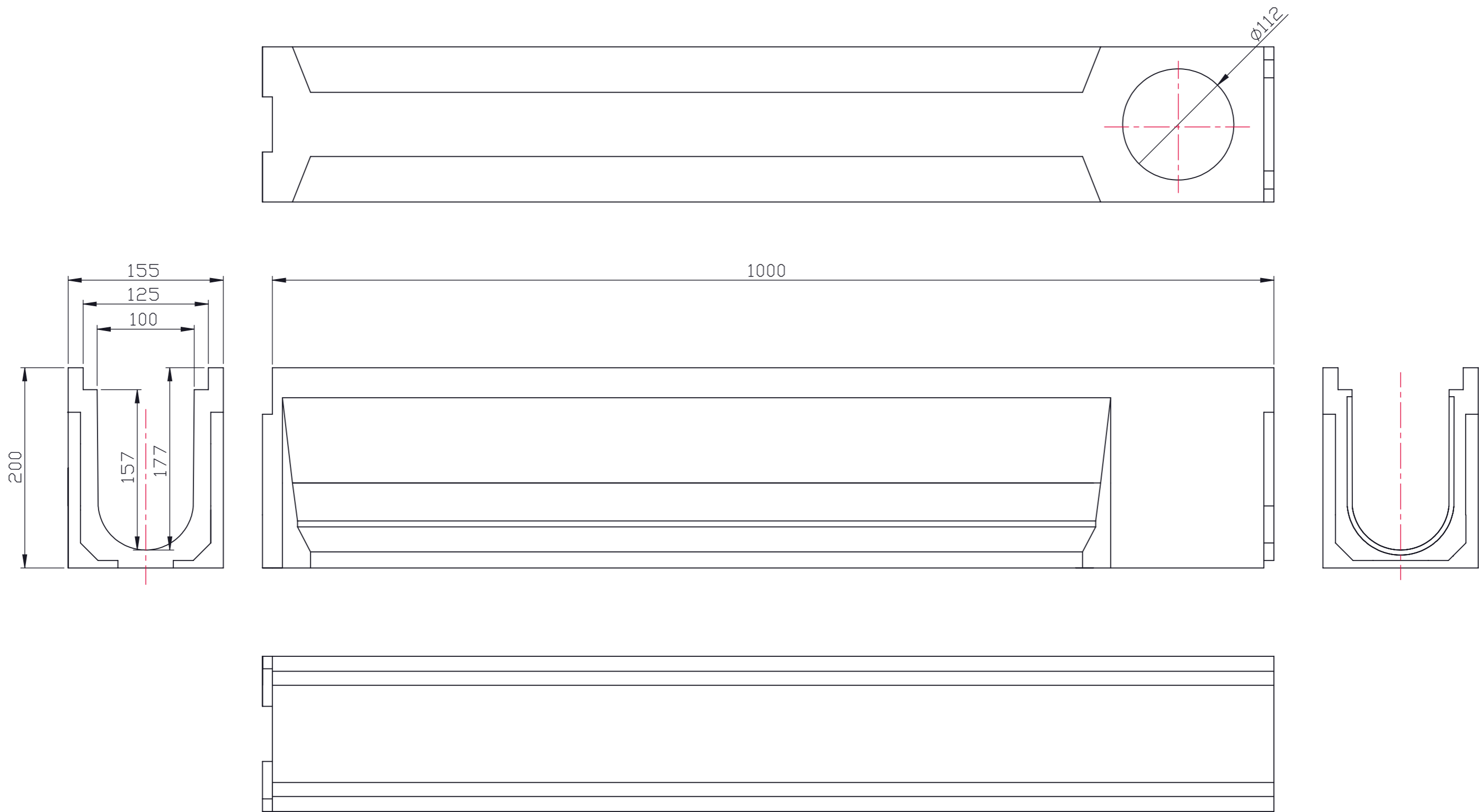

 STORA-DRAIN	Nazwa: TOP B=100 H=200 L=1000
Rodzaj materiału: polimerobeton	Klasa wytrzymałości: A15 - C250
Ochrona krawędzi: -	Numer artykułu: ST10201000

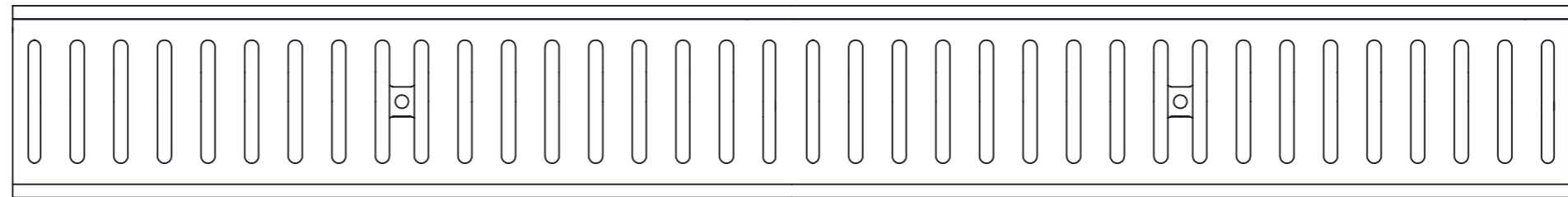
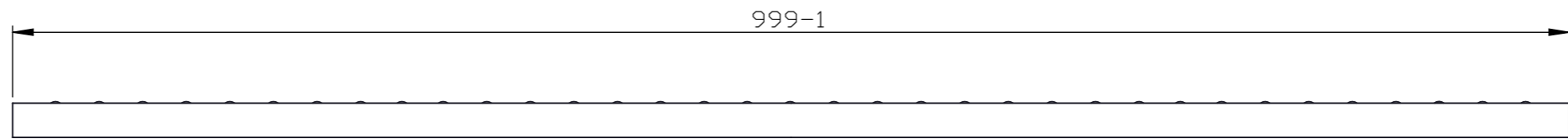
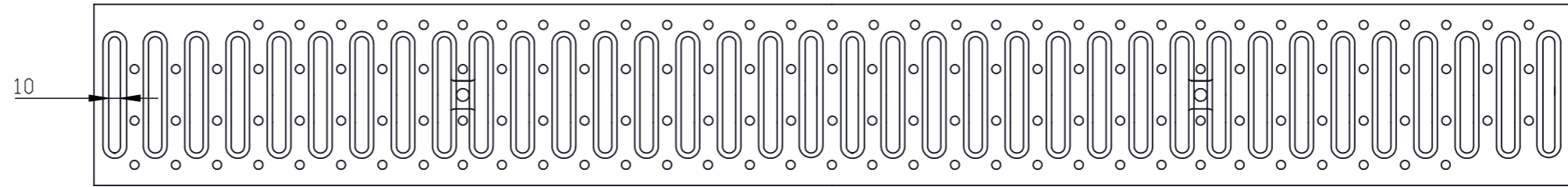
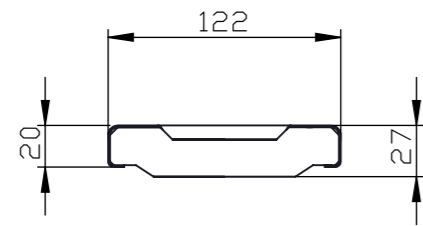

 STORA-DRAIN	Nazwa: Ruszt PARKING B=100
Rodzaj materiału: stal nierdzewna lub ocynkowana	Klasa wytrzymałości: A15
Rodzaj mocowania: śruba M8	Numer artykułu: RSP100A104

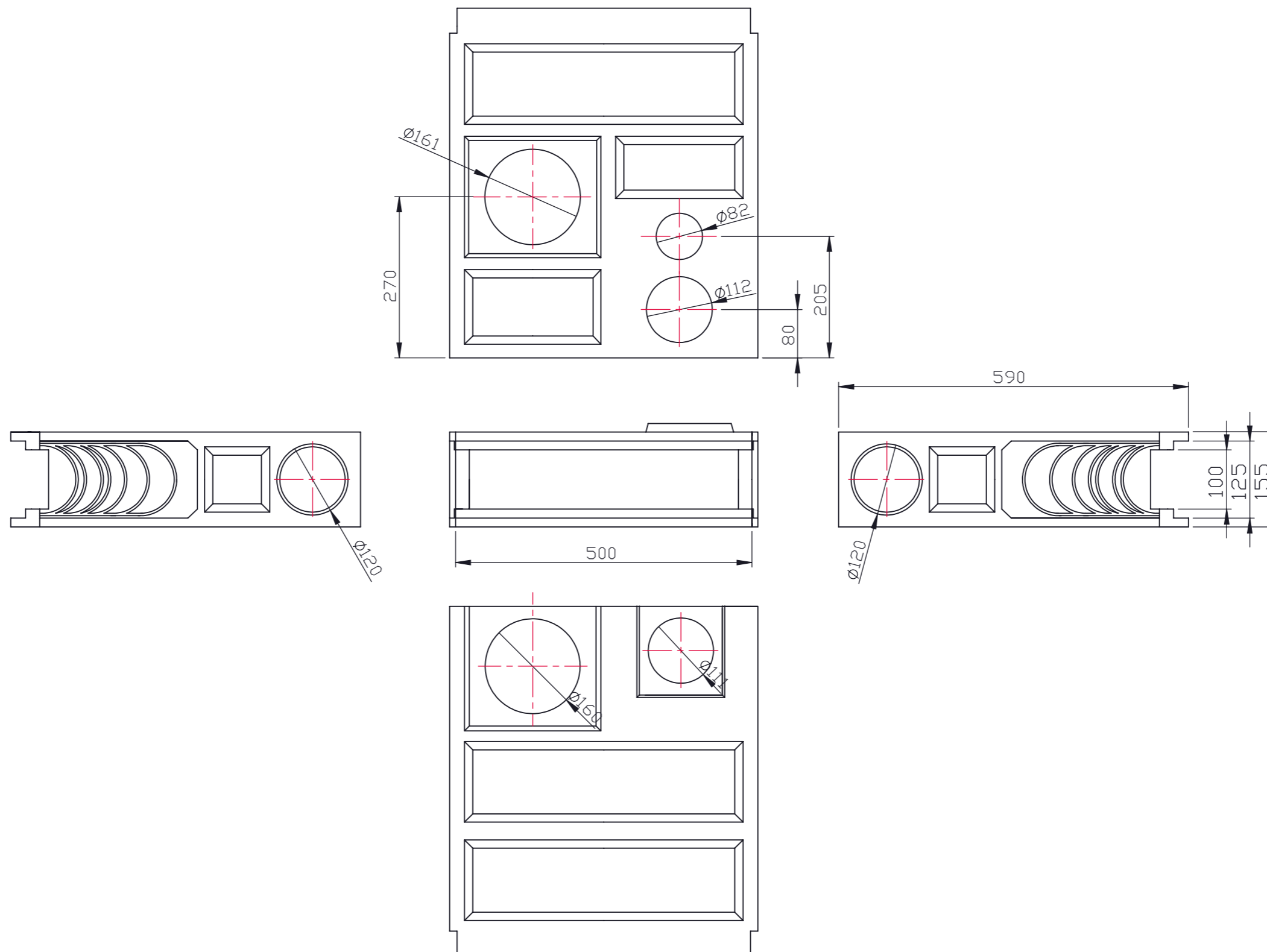

 **STORA-DRAIN**

Nazwa:
Osadnik piasku TOP
B=100 H=590 L=500

Rodzaj materiału:
polimerobeton

Klasa wytrzymałości:
C250

Ochrona krawędzi:
-

Numer artykułu:
AU1010000